



Quilt Block Pattern

by Olesya Lebedenko

Developed exclusively for BERNINA Canada.



Visit me on Instagram: ([@olesyalebedenkodesign](#))

Click here to check my patterns on Etsy: ([MyPieceFullJourney](#))

6" BLOCK FINISHED SIZE

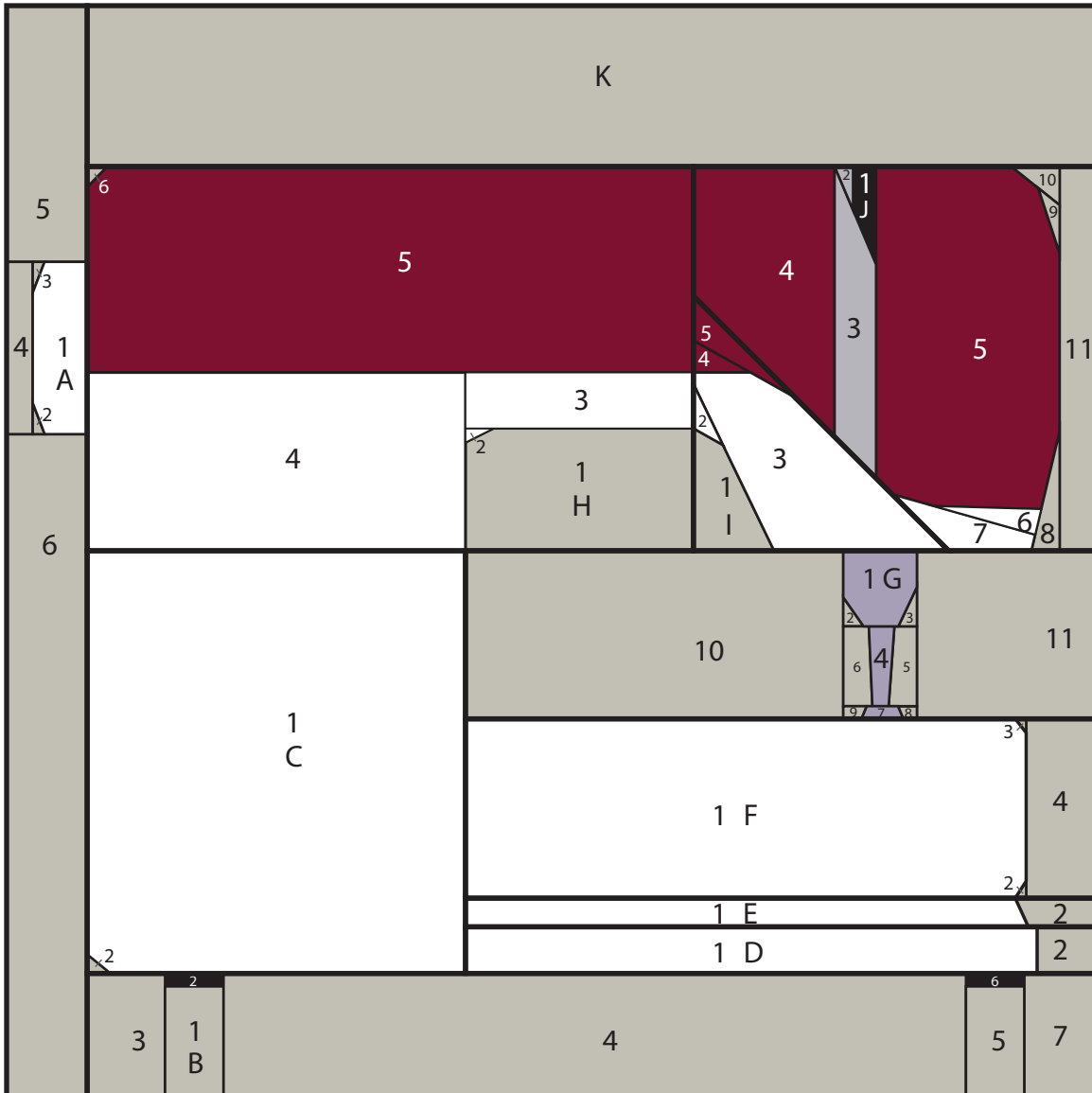

This block pattern is intentionally printed in reverse.
Your finished block will be correctly oriented, as per the cover image.

When printing the paper copy of the pattern choose in printer's settings «actual size (full size, 100%)».

6" BLOCK FINISHED SIZE

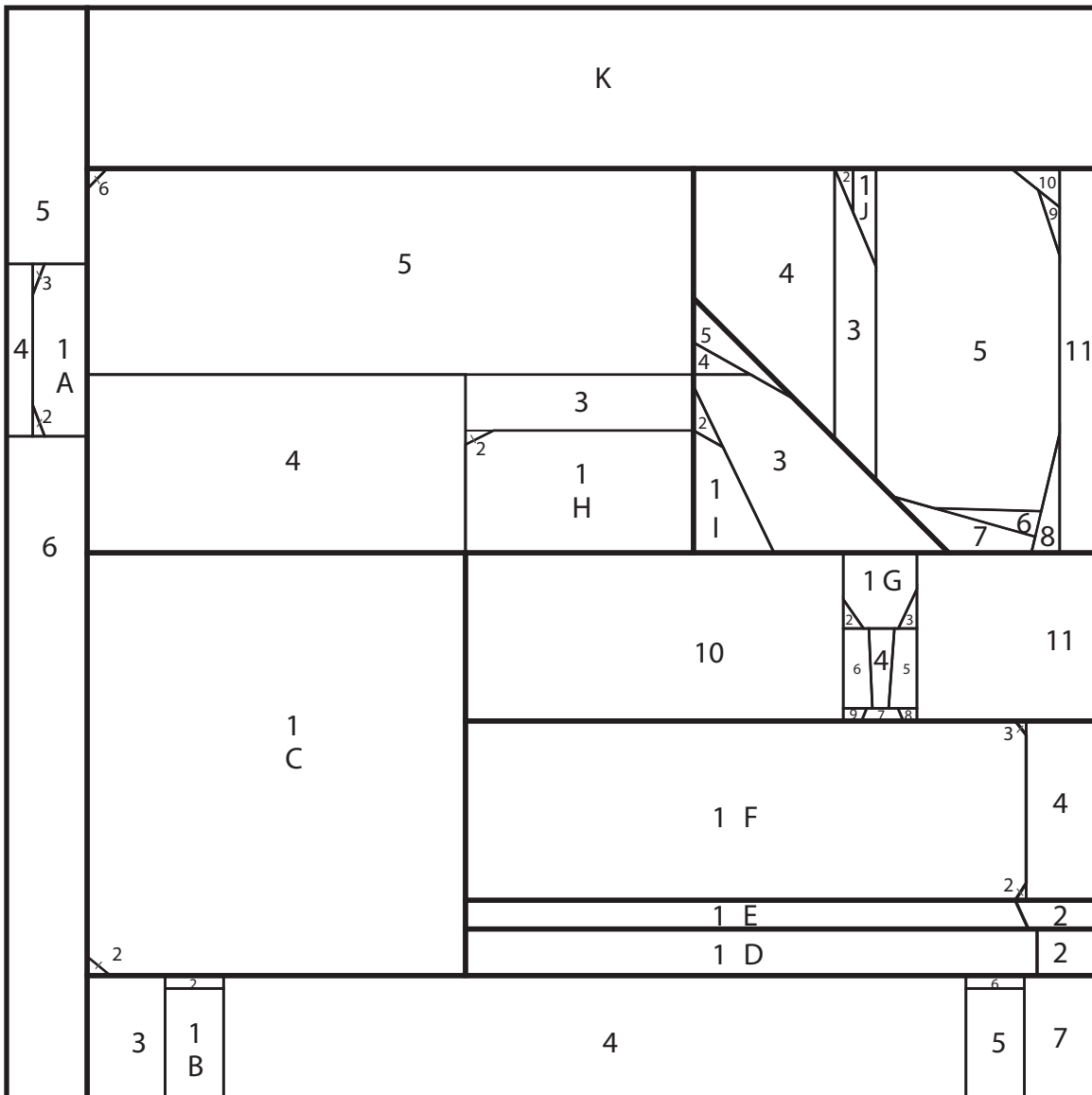

The formula:

A: $(1+2+3)+4+5+6$

B: $(1+2)+3+4+(5+6)+7$

C: $1+2$

D: $1+2$

E: $1+2$

F: $(1+2+3)+4$

G: $((1+2+3)+(4+5+6)+(7+8+9))+10+11$

H: $(1+2)+3+4+5+6$

I: $1+2+3+4+5$

J: $(1+2+3)+4+(5+6+7+8+9+10)+11$

$((J+I+H)+K)+((G+F+E+D) +C)+B)+A$

6" BLOCK FINISHED SIZE

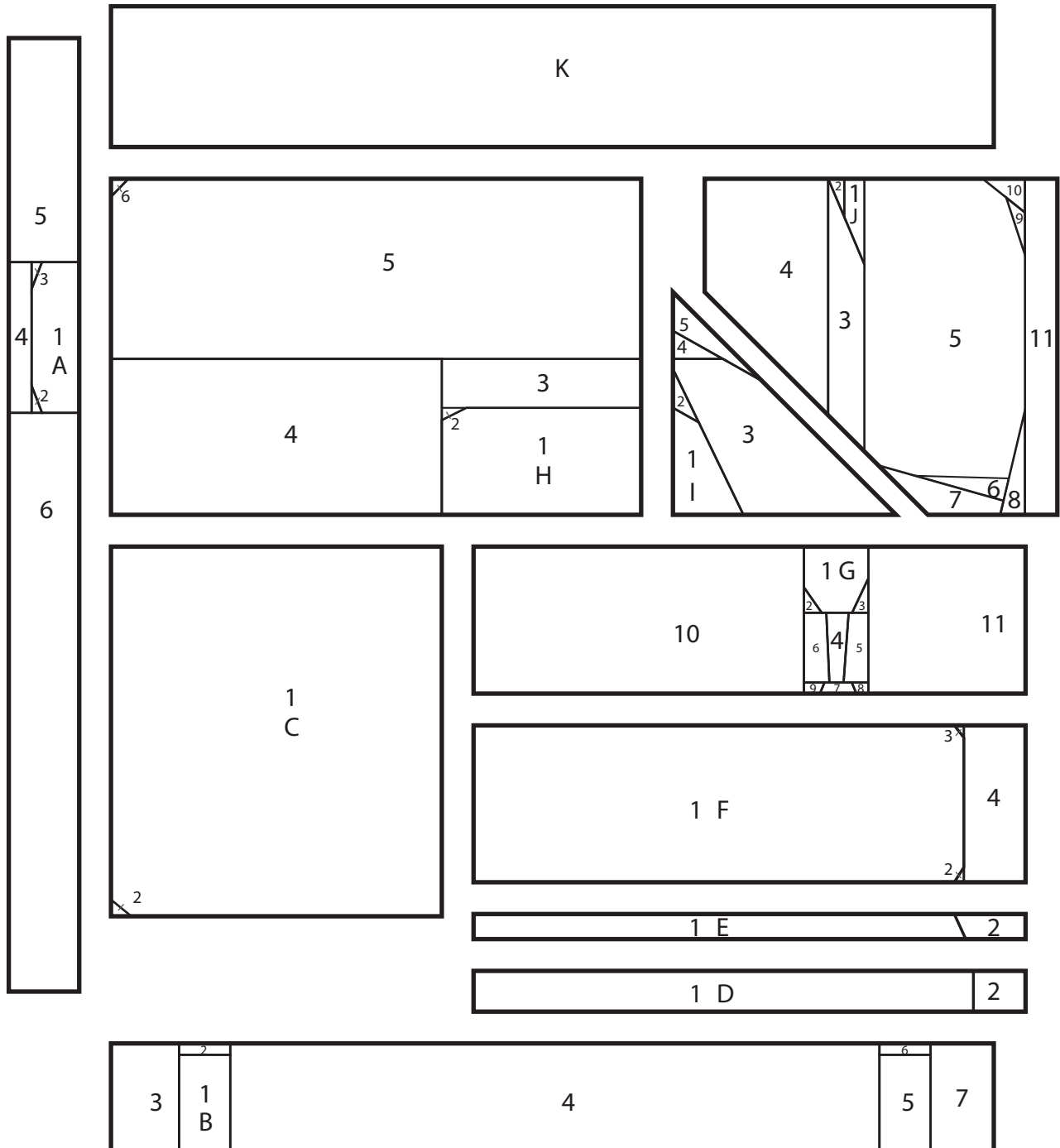

When printing the paper copy of the pattern choose in printer's settings «actual size (full size, 100%)».

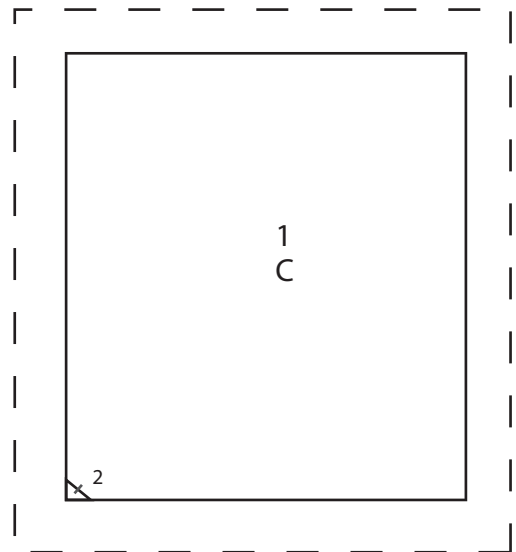
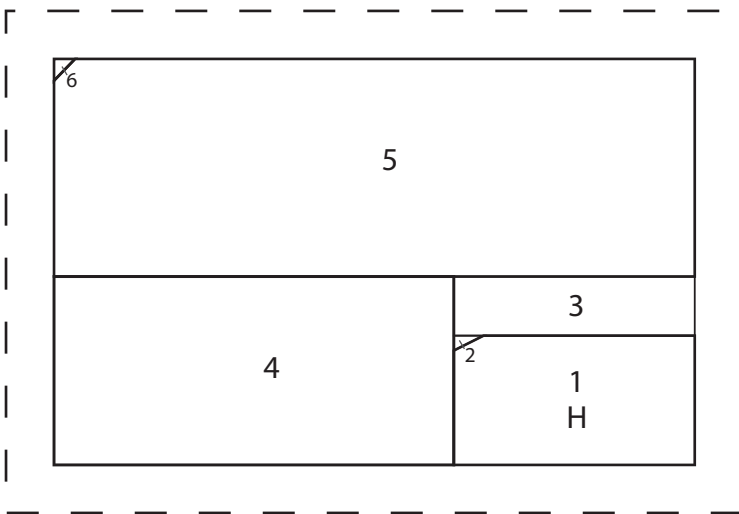
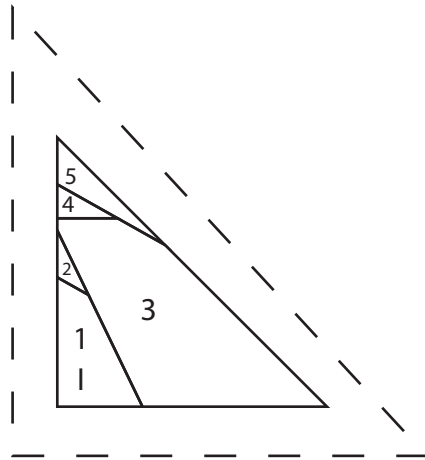
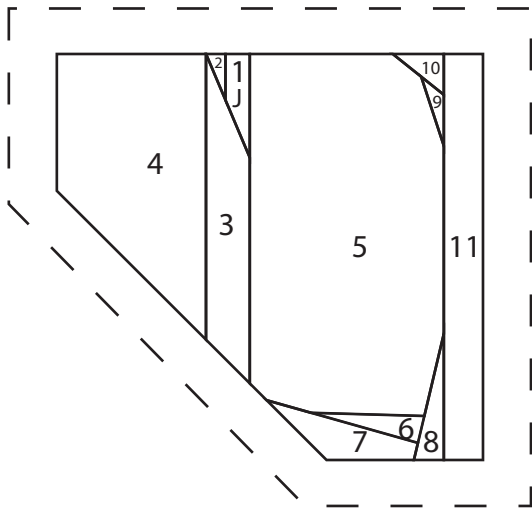
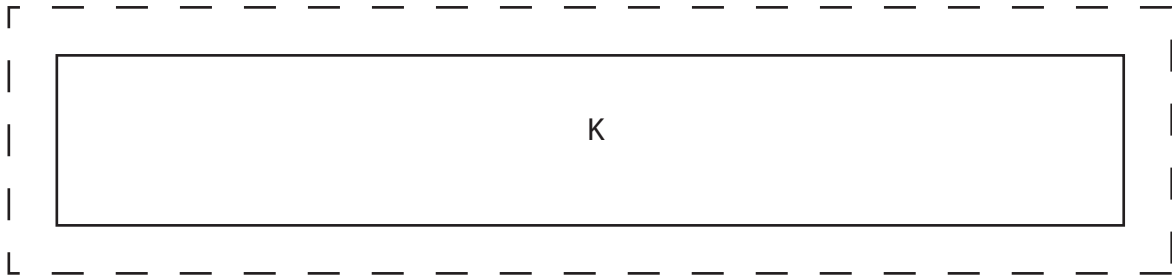

When printing the paper copy of the pattern choose in printer's settings «actual size (full size, 100%)».

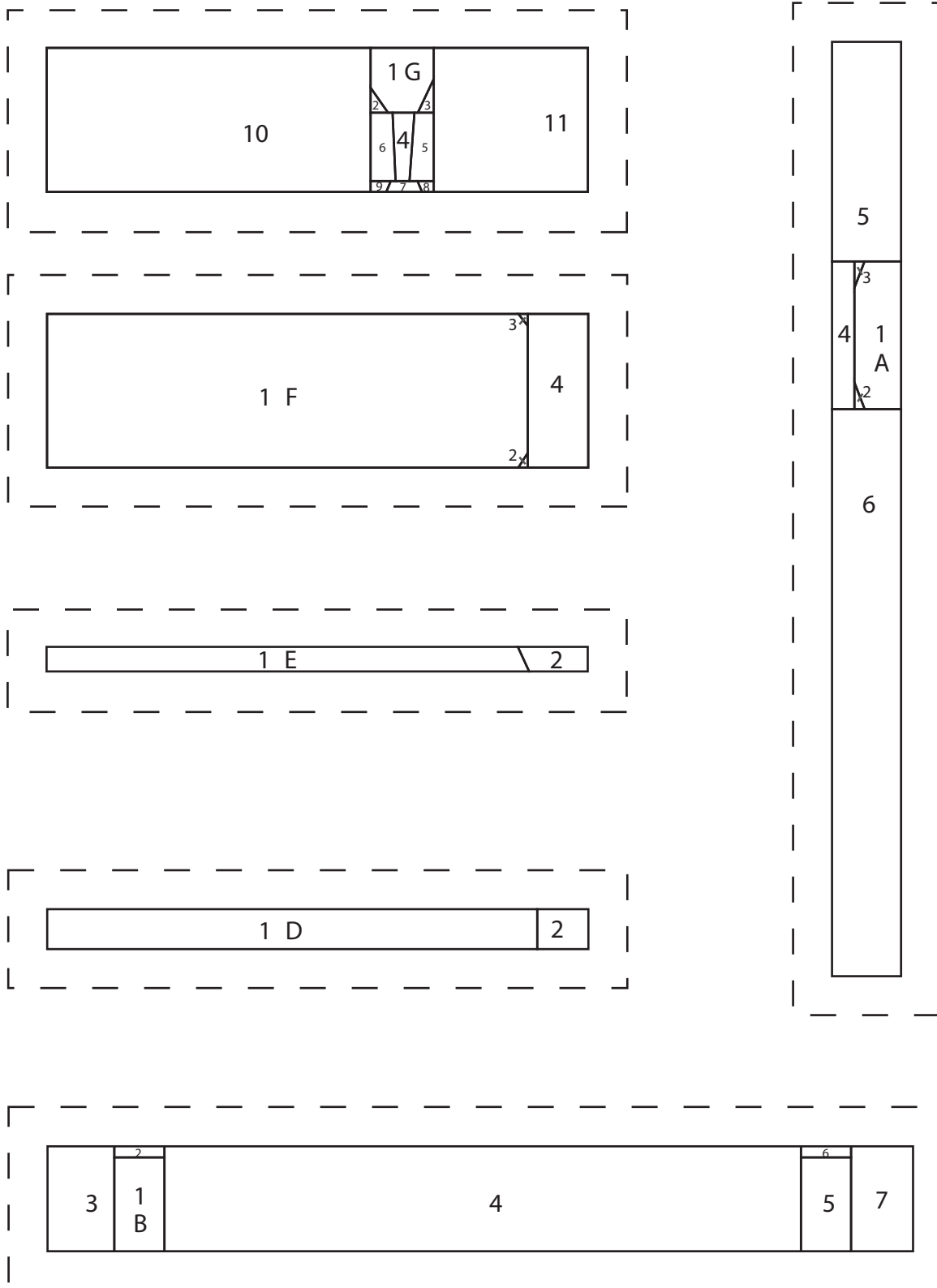

When printing the paper copy of the pattern choose in printer's settings «actual size (full size, 100%)».

SCALE 1:1

f1 TEMPOR

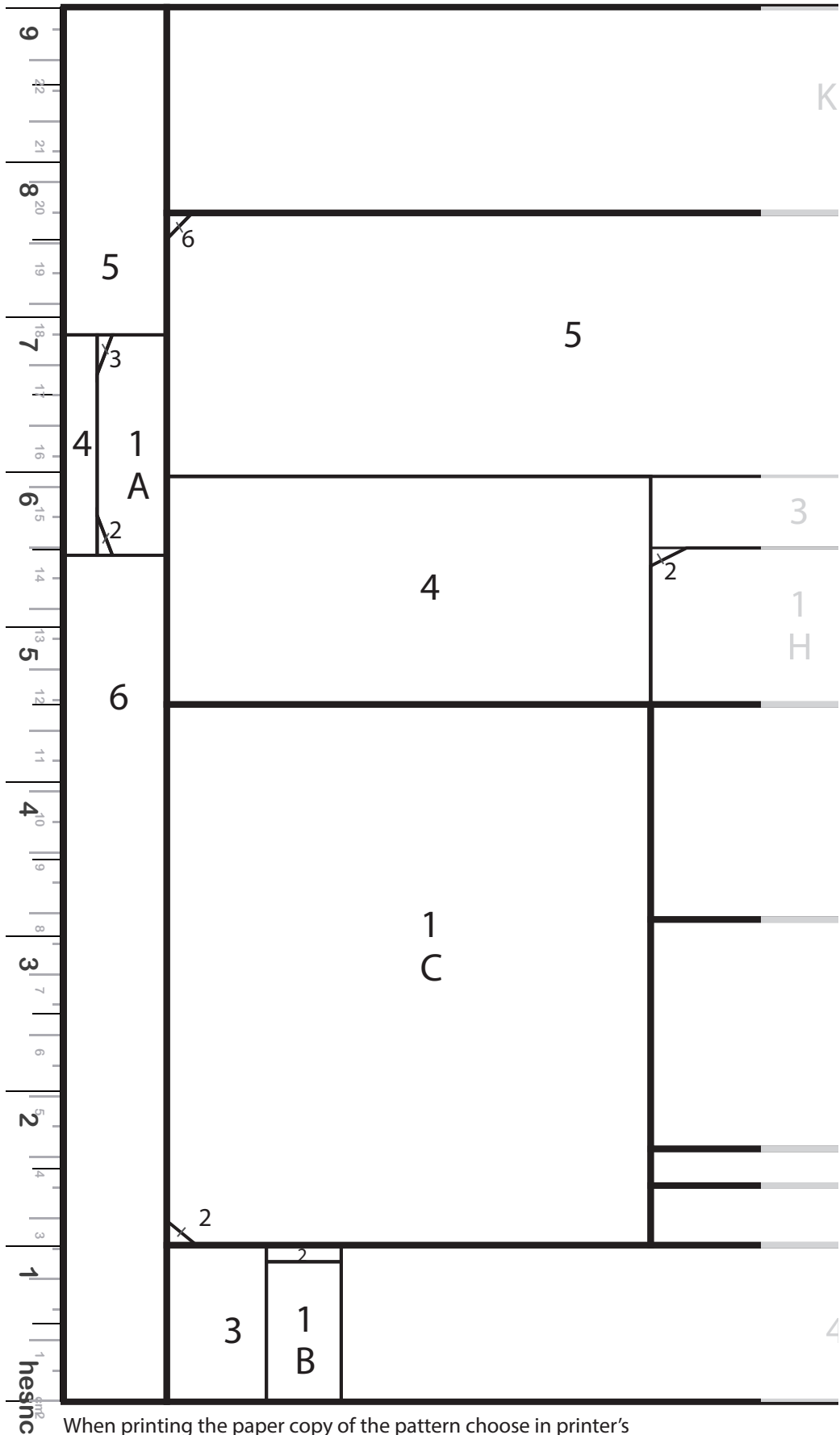

When printing the paper copy of the pattern choose in printer's settings «actual size (full size, 100%)».

www.facebook.com/365daysquiltscraps
www.patreon.com/olesyalebedenkodesign
www.instagram.com/olesyalebedenkodesign
www.olesya-l-design.com



SCALE 1:1

t2
TEMPOR

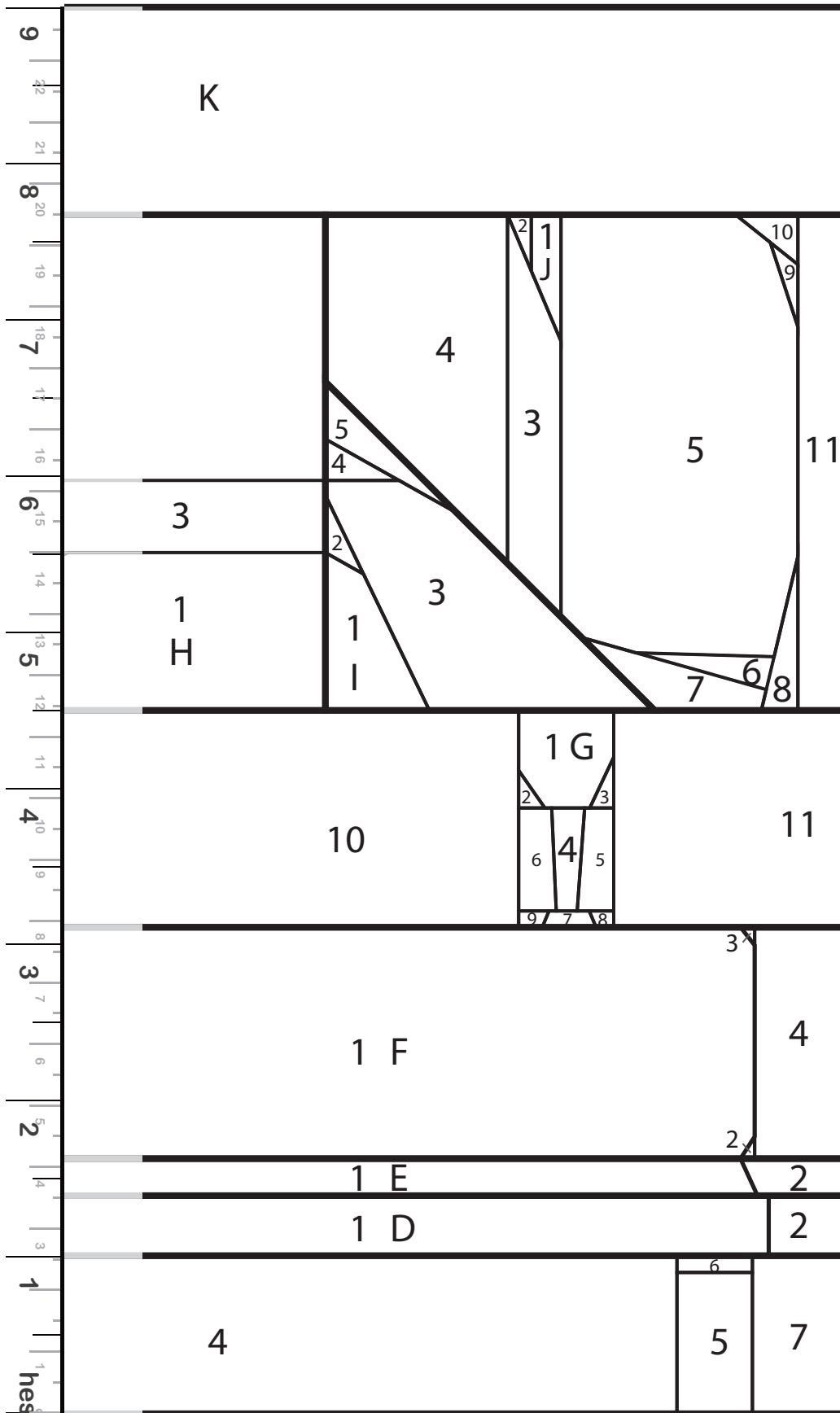

When printing the paper copy of the pattern choose in printer's settings «actual size (full size, 100%)».

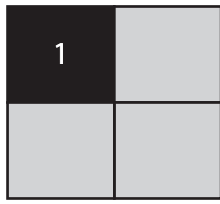

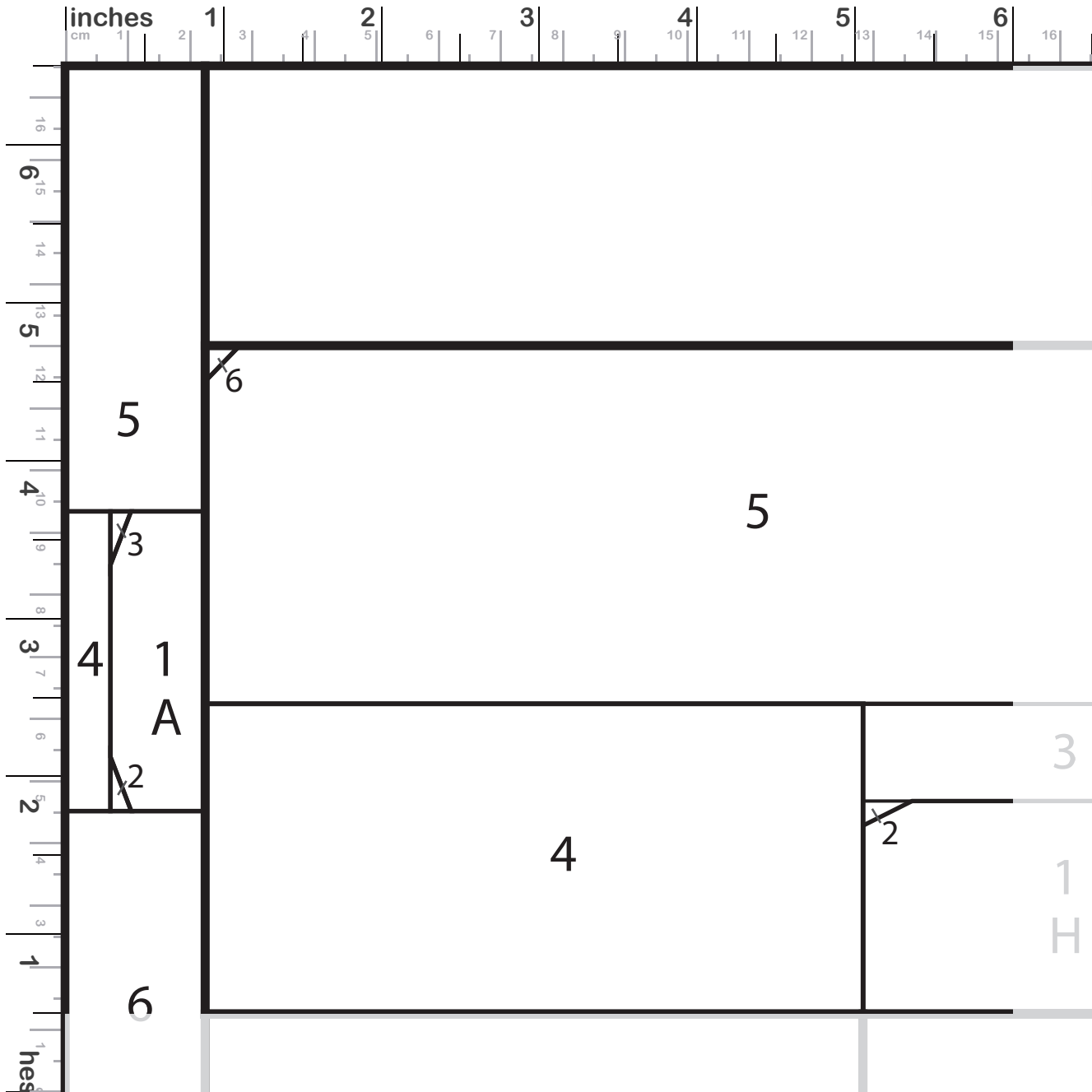

12" PATTERN: part 1

SCALE 1:1



When printing the paper copy of the pattern choose in printer's settings «actual size (full size, 100%)».



 www.facebook.com/365daysquiltscraps
 www.patreon.com/olesyalebedenkodesign
 www.instagram.com/olesyalebedenkodesign
www.olesya-l-design.com

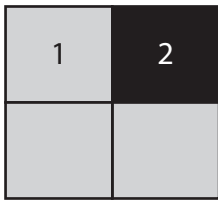

12" PATTERN: part2

SCALE 1:1

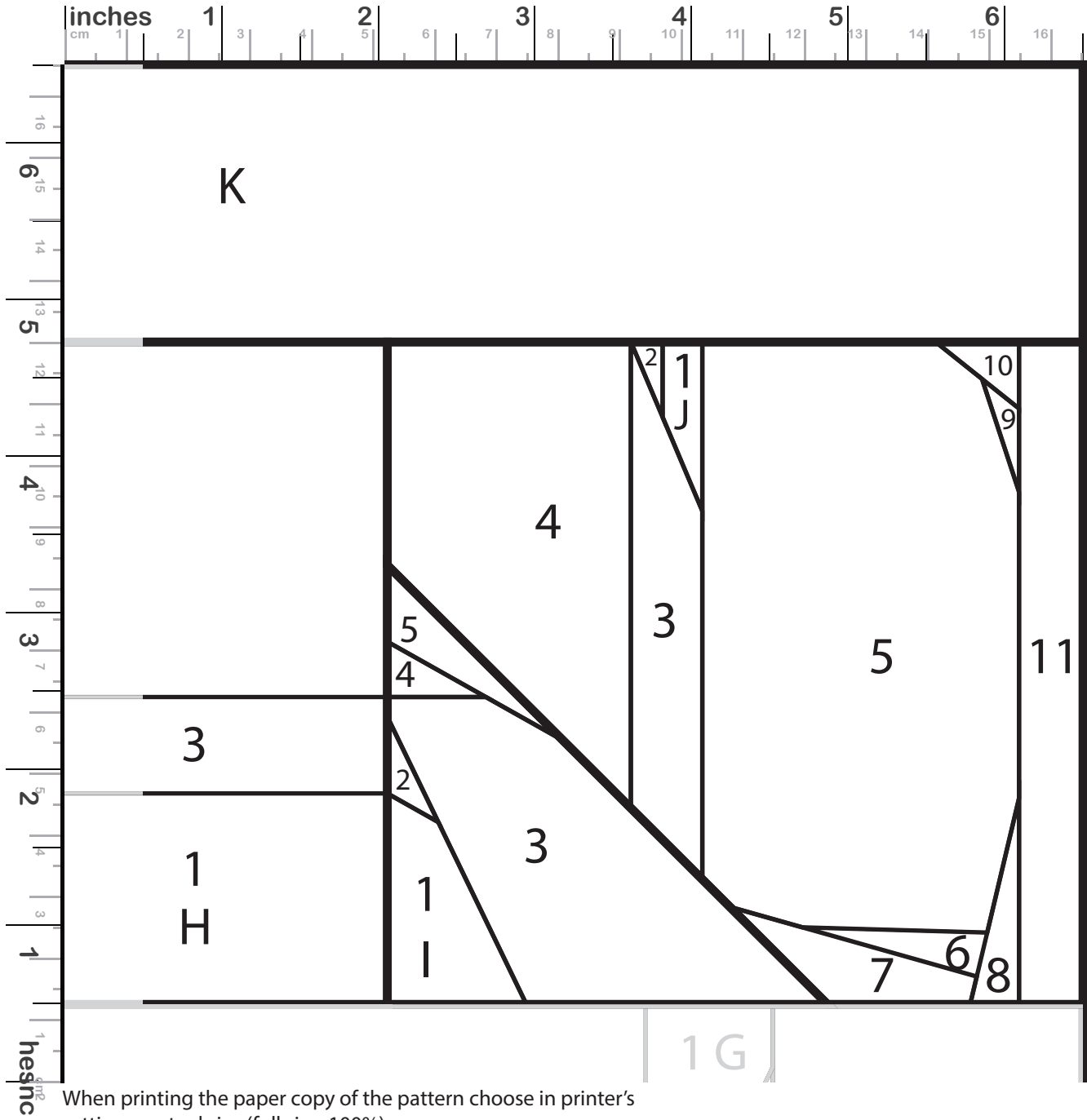

When printing the paper copy of the pattern choose in printer's settings «actual size (full size, 100%)».

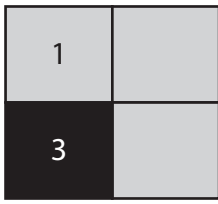

12" PATTERN: part3

SCALE 1:1

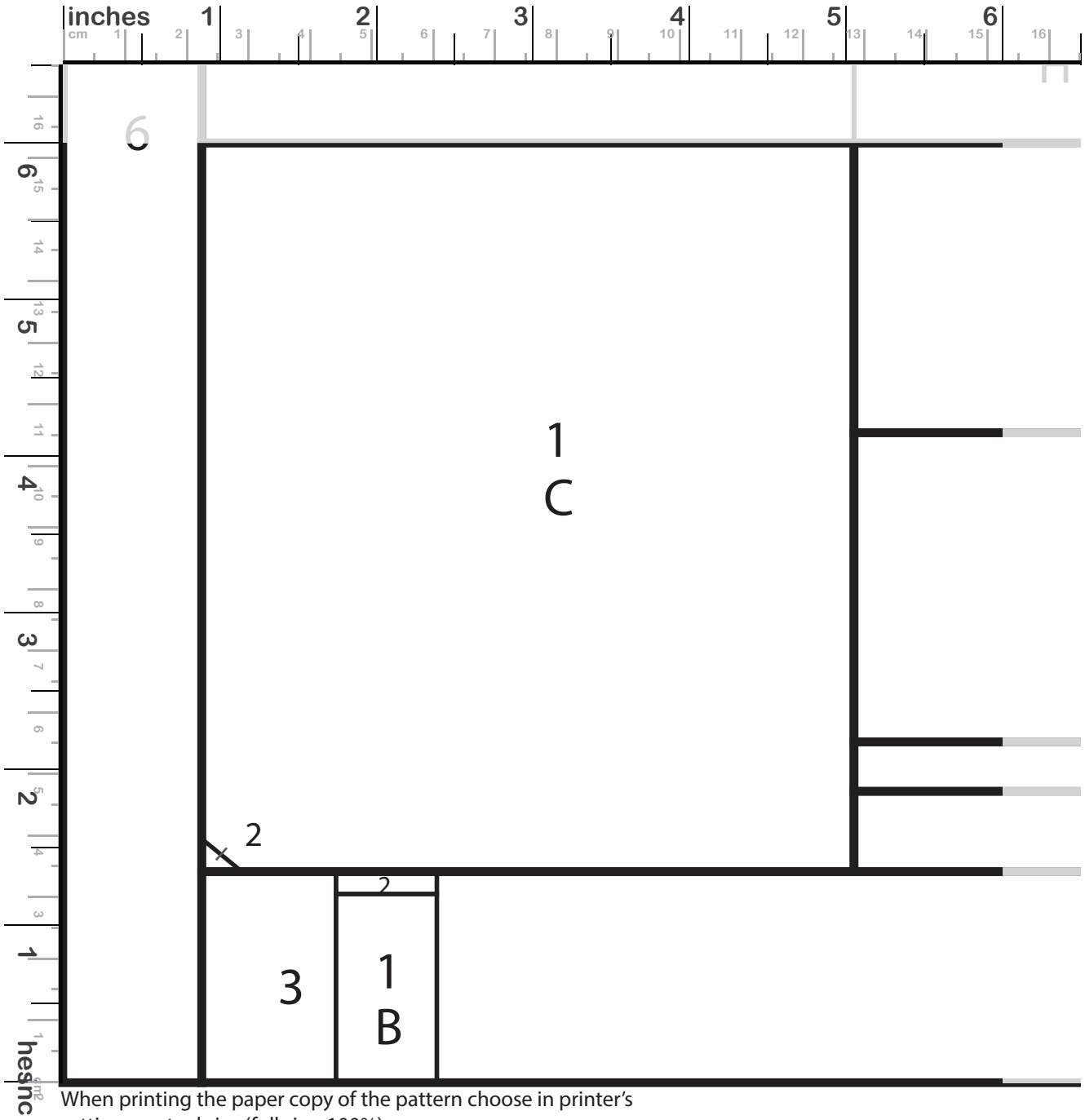

When printing the paper copy of the pattern choose in printer's settings «actual size (full size, 100%)».

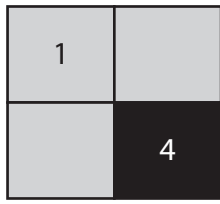

12" PATTERN: part4

SCALE 1:1

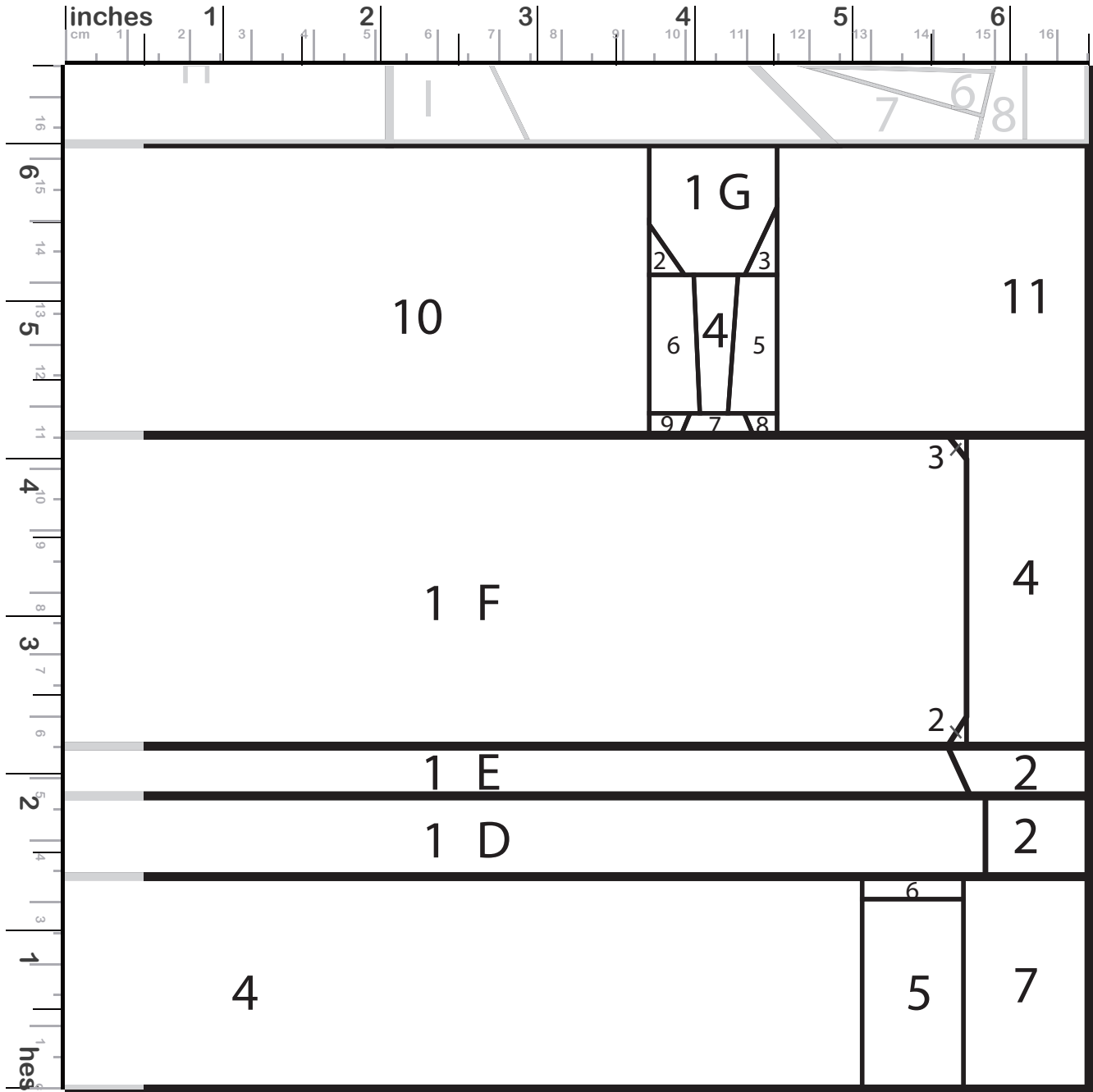

When printing the paper copy of the pattern choose in printer's settings «actual size (full size, 100%)».